

345C/345C L

Hydraulic Excavator



Engine

Engine Model	Cat® C13	
Net Flywheel Power	239 kW	321 hp

Weights

Operating Weight – Long Undercarriage	44 970 kg	99,150 lb
--	-----------	-----------

- Reach Boom, R3.9 (12'10") stick, 1219 mm (48") GP-C Bucket and 750 mm (30") shoes.

345C/345C L Hydraulic Excavator

The 345C/345C L hydraulic excavator's high performance and rugged durability combine to maximize your productivity.

C13 Engine with ACERT™ Technology

- ✓ ACERT Technology works at the point of combustion to optimize engine performance and provide low exhaust emissions to meet EU Stage II emission regulations, with exceptional performance capabilities and proven reliability. **pg. 4**

Hydraulics

- ✓ The 345C L hydraulic system has been re-designed to improve reliability and to add a new Tool Control System. **pg. 5**

Operator Station

- ✓ Provides the maximum space, wider visibility and easy access to switches. The monitor has been changed to a full-color graphical display to allow operator to understand the machine information easily. Overall, the new cab provides a comfortable environment for the operator. **pg. 6**

Boom, Sticks and Attachments

- ✓ Three length of booms and six types of sticks are available, offering a range of configurations suitable for a wide variety of application conditions. The bucket linkage pins have been enlarged to improve reliability and durability. All booms and stick are stress relieved. **pg. 11**

Work Tools

A variety of work tools, including buckets, couplers, hammers, and shears are available through Cat Work Tools. **pg. 12**

Outstanding performance. Excellent control, high stick and bucket forces, impressive lift capacity, simplified service and a more comfortable operator station to increase your productivity and lower operating costs.



Electronic Control System

ADEM™ A4 electronic engine controller maximizes fuel efficiency and performance by maintaining the optimum balance between engine speed and hydraulic demand. **pg. 8**

Undercarriage

- ✓ Cat designed excavator undercarriage is stable, durable and low maintenance. Available in Standard Fixed, Variable and Long Fixed gauge configurations to meet lift capacity and bucket size needs. **pg. 9**

Structures

Caterpillar® design and manufacturing techniques assure outstanding durability and service life from these important components. The 345C L uses thicker plates at the boom foot area to improve rigidity. **pg. 10**

Service and Maintenance

- ✓ Fast, easy service has been designed in with extended service intervals, advanced filtration, convenient filter access and user-friendly electronic diagnostics for increased productivity and reduced maintenance costs. **pg. 14**

Complete Customer Support

Your Cat dealer offers a wide range of services that can be set up under a customer support agreement when you purchase your equipment. The dealer will help you choose a plan that can cover everything from machine configuration to eventual replacement. **pg. 15**



✓ *New Feature*

C13 Engine with ACERT™ Technology

Built for power, reliability, economy and low emissions.



Performance. The C13 with ACERT™ Technology offers 21% greater displacement than the 3176C, and runs at 10% lower speeds for better fuel economy and reduced wear. The 345C L, equipped with the C13 provides 8% more horsepower compared to the 3176C in the 345B Series II.

Fuel Consumption. With ACERT Technology, the C13 meets EU stage 2 emissions while delivering good fuel economy.

Emissions. ACERT Technology is a differentiated technology that reduces emissions at the point of combustion. Caterpillar technology capitalized on the proven leadership in three core engine systems: fuel, air and electronics.

Low Sound and Vibration Levels.

The engine mounts are rubber-isolating mounts matched with the engine package to provide optimum sound and vibration reduction. Further noise reduction has been achieved through design changes to the isolated top cover, oil pan, multiple injection strategy, insulated timing cover, sculpted crankcase.

Fuel System. The Cat C13 features electronic controls that govern the mechanically actuated unit fuel injection (MEUI) system. MEUI provides the high-pressure required to help reduce particulate emissions and deliver better fuel economy through finer fuel atomization and more complete combustion.

Cooling System. The 345C L layout separates the cooling system from the engine compartment. The cooling fan is hydraulically driven with a variable speed control that manages fan speed to provide optimized cooling.

Air Cleaner. The radial seal air filter features a double-layered filter core for more efficient filtration and is located in a compartment behind the cab. A warning is displayed on the monitor when dust accumulates above a preset level.

Turbocharger. The Cat C13 uses a wastegate turbocharger for improved performance.

- The wastegate valve controls excessive engine boost pressure by allowing exhaust to bypass the exhaust-side turbine.
- The wastegate all reduces turbine wear in high RPM, low load conditions and optimizes air and fuel delivery for peak performance.
- The turbocharger increases the density of the air, enabling the engine to produce more power with few effects from altitude.

Cold Weather Starting Kit. The kit consists of four batteries, heavy-duty harness, large capacity starting motor and the ether starting aid. With this kit, the 345C L has the capability to start at 32° C (-25.6° F).

Hydraulics

Cat hydraulics deliver power and precise control to keep material moving.

Pilot System. The hydraulic pilot system controls the front linkage, swing and travel operations.

Component Layout. The 345C L hydraulic system and component locations have been designed to provide a high level of overall system efficiency.

Hydraulic Cross-Sensing System. The two main hydraulic pumps use 100 percent of available horsepower resulting in faster implement speeds and increased productivity.

Boom and Stick Regeneration Circuit. Saves energy during boom-down and stick-in operation, providing shorter cycle times and lower operating costs.

Boom and Swing Priority. The hydraulic system on the 345C L provides automatic priority function for boom-up and swing operations eliminating the need for work mode buttons. When the boom or swing lever is activated, the system automatically assigns priority based on operator demand.

Auxiliary Hydraulic Valve. The auxiliary valve is standard on the 345C L. Control circuits are available as attachments, allowing operation of high and medium pressure tools such as shears, grapples, hammers, pulverizers, multi-processors and vibratory plate compactors.

Hydraulic Cylinder Snubbers. Snubbers are located at the rod-end of the boom cylinders and both ends of the stick cylinders to cushion shocks while reducing sound levels and extending component life.



Operator Station

Designed for simple, easy operation, the 345C L allows the operator to focus on production.



Cab Design. The workstation is spacious, quiet and comfortable, assuring high productivity during a long work day. The air conditioner and attachment switches are conveniently located on the right-hand wall, and the key switch and throttle dial are on the right-hand console. The monitor is easy to see and maximizes visibility.

Seat. A new optional air suspension seat is available in the 345C L. The standard and optional seats provide a variety of adjustments to suit the operator's size and weight including fore/aft, height and weight. Wide adjustable armrests and a retractable seat belt are also included.

Hydraulic Activation Control Lever.

For added safety, this lever must be in the operate position to activate the machine control functions.

Climate Control. Positive filtered ventilation with a pressurized cab comes standard on the 345C L. Fresh air or re-circulated air can be selected with a switch on the left console.

Windows. To maximize visibility, all glass is affixed directly to the cab, eliminating window frames. The upper front windshield opens, closes and stores on the roof above the operator with a one-touch action release system.

Wipers. Pillar-mounted wipers increase the operator's viewing area and offer continuous and intermittent modes.

Skylight. An enlarged skylight with sunshade provides excellent visibility and good ventilation.



Console. Redesigned consoles feature a simple, functional design to reduce operator fatigue, ease of switch operation and excellent visibility. Both consoles have attached armrests with height adjustments.

Monitor. The compact, full-color, graphical display monitor, new with the 345C L, displays machine, maintenance, diagnostic and prognostic information, in twenty different languages. Monitor angle can be adjusted to minimize sun glare.

Cab Exterior. The exterior design uses thick steel tubing along the bottom perimeter of the cab, improving the resistance of fatigue and vibration. This design allows the FOGS to be bolted directly to the cab, at the factory or as an attachment later, enabling the machine to meet specifications and job site requirements.

Cab Mounts. The cab shell is attached to the frame with viscous rubber cab mounts, which dampen vibrations and sound levels while enhancing operator comfort.

Standard Cab Equipment. To enhance operator comfort and productivity, the cab includes a lighter, drink holder, coat hook, service meter, literature holder, magazine rack and storage compartment.

Machine Security. An optional Machine Security System is available from the factory on the 345C L. This system controls when the machine can be operated and utilizes specific keys to prevent unauthorized machine use, a significant theft deterrent.

Product Link. Product Link is now an attachment available from the factory on the 345C L.

Electronic Control System

Manages the engine and hydraulics for maximum performance.

Travel Controls. The 345C L uses pilot operated control levers, positioned so the operator can operate with arms on the armrests. The vertical stroke is longer than the horizontal stroke, reducing operator fatigue. The control lever grips are shaped to fit into the operator's hands. The horn switch and one-touch low idle switch are positioned on the left and right grip.

Controllers. The mechanically actuated unit injection system features a high-pressure fuel injection system, proven to significantly reduce fuel consumption and particulate emission. Electronic Unit Injection (EUI) produces high-pressure and affords the integration of electronics with fewer components. The modular design of the electronic control system allows greater update, flexibility, improves serviceability and lowers repair costs.

Keypad. The keypad allows operator to select machine operation conditions and to set view preferences.

ADEM™ A4 Engine Controller.

The ADEM A4 electronic control module manages fuel delivery to get the best performance per liter or gallon of fuel used. The engine management system provides flexible fuel mapping, allowing the engine to respond quickly to varying application needs. It tracks engine and machine conditions while keeping the engine operating at peak efficiency.



Monitor Display Screen. The monitor is a full color 400x234 pixels Liquid Crystal Display (LCD) graphic display.

The Master Caution Lamp blinks ON and OFF when one of these critical conditions occur:

- Engine oil pressure low
- Coolant temperature high
- Hydraulic oil temperature high

Under the normal condition or the default condition, the monitor display screen is divided into four areas: clock and throttle dial area, gauge area, event display area and multi-information display area.

Clock and Throttle Dial Area. The clock and the throttle dial position are in this area and the gas-station icon with green color is also displayed.

Gauge Area. Three analog gauges, fuel level, hydraulic oil temperature and coolant temperature, are displayed in this area.

Event Display Area. Machine information is displayed in this area with graphic icons plus written messages in twenty different languages including Czech, Danish, Dutch, English, Finnish, French, German, Greek, Icelandic, Indonesian, Italian, Japanese, Norwegian, Portuguese, Russian, Simplified Chinese, Spanish, Swedish, Thai and Turkish.

Multi-information Display Area.

This area is reserved for displaying information that is convenient for the operator. The "CAT" logo mark is displayed when information to display does not exist.

Undercarriage

Durable undercarriage absorbs stresses and provides excellent stability.



Travel Motors. Two-speed axial piston hydraulic motors provide the 345C L drive power and speed selection which is automatic when the high-speed position is selected. This enables the machine to automatically change between computer-controlled high and low speeds depending on drawbar-pull requirements.

Straight-line Travel Circuit. The straight-line travel circuit is incorporated into the hydraulic system, which maintains low-speed, straight-line travel, even when operating the front linkage.

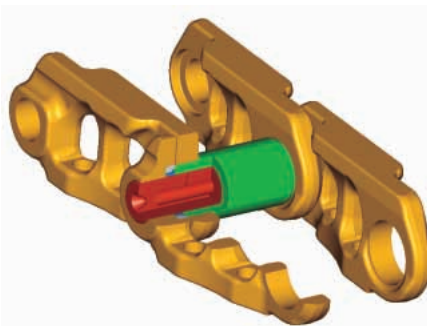

Track. The 345C L comes standard with the new grease lubricated track called GLT4. The track links are assembled and sealed with grease to decrease internal bushing wear, reduce travel noise and extend service life lowering operating costs.

Final Drive. The final drives are a new compact design with three-stage planetary reduction. This design results in a complete drive/brake unit that is compact and delivers excellent performance and reliability.

Track Guards. The idler guard and bolt-on center guard are standard equipment. They help maintain track alignment while traveling or working on slopes. For applications that require additional track protection or alignment, optional guards are available.

Structures

The 345C L structural components are the backbone of the machine's durability.

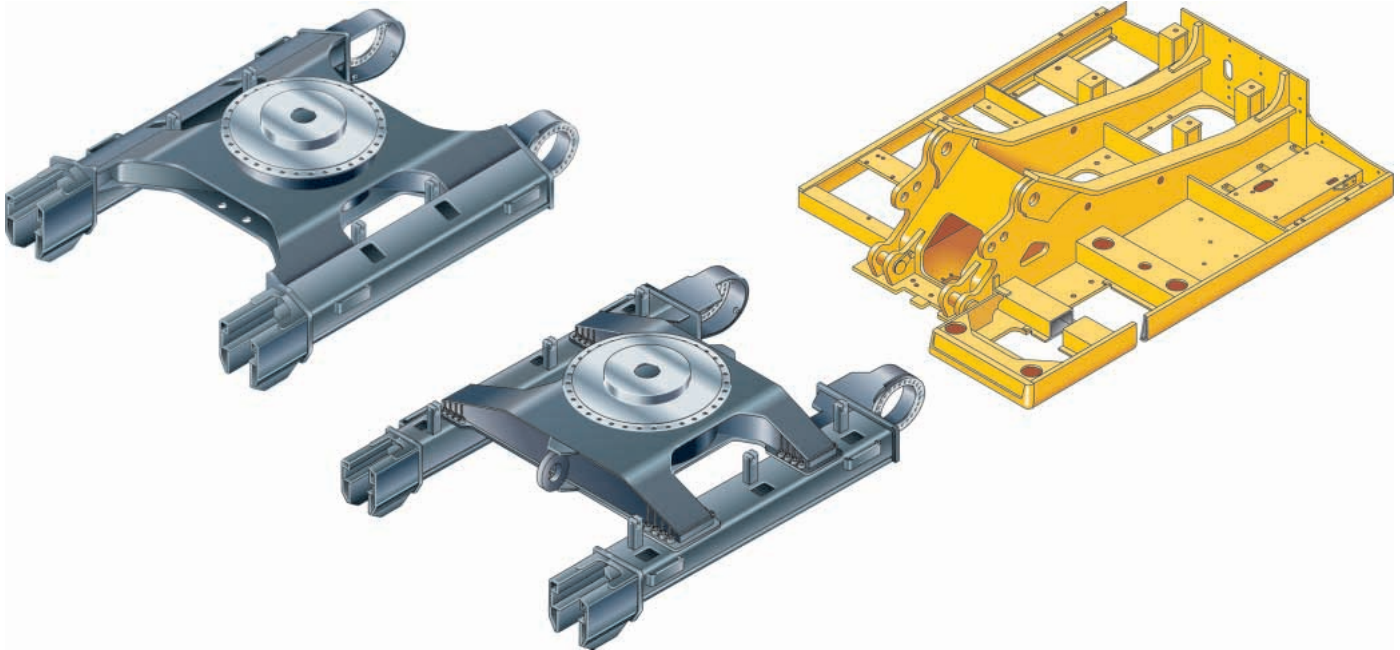

Carbody. The 345C L has three undercarriage options to meet regional transportation requirements and application needs.

- Standard (STD) undercarriage is well suited for applications that require frequent repositioning of the machine, have restricted working space, or have uneven or rocky terrain.
- Fixed gauge for narrow transport and weight sensitive areas.
- Variable gauge for increased track and ground clearance and over-side lift.

Track Roller Frame. Fixed Gauge Undercarriage

- Uses a press-formed, pentagonal section for the track frame that is robot-welded for weld consistency and quality. The track frame has been designed so that the top of the track frame has a steep angle to help prevent accumulation of mud and debris.

Variable Gauge Undercarriage

- The track roller frame is made of thick steel plate that is bent into a U-shape and welded to the bottom plate to create a box structure. The box structure design for increased rigidity and impact resistance.

Upper Frame. The rugged main frame has been narrowed to improve transportability and is designed for maximum durability. Robot welding is used for consistent, high-quality welds. The main channels are box sections connected by a large diameter tube in the boom foot area to improve rigidity and strength. The outer frame utilizes curved side rails for rigidity against bending and torsional loads.

Boom, Sticks and Attachments

Designed for maximum flexibility to keep productivity and efficiency high on all jobs.

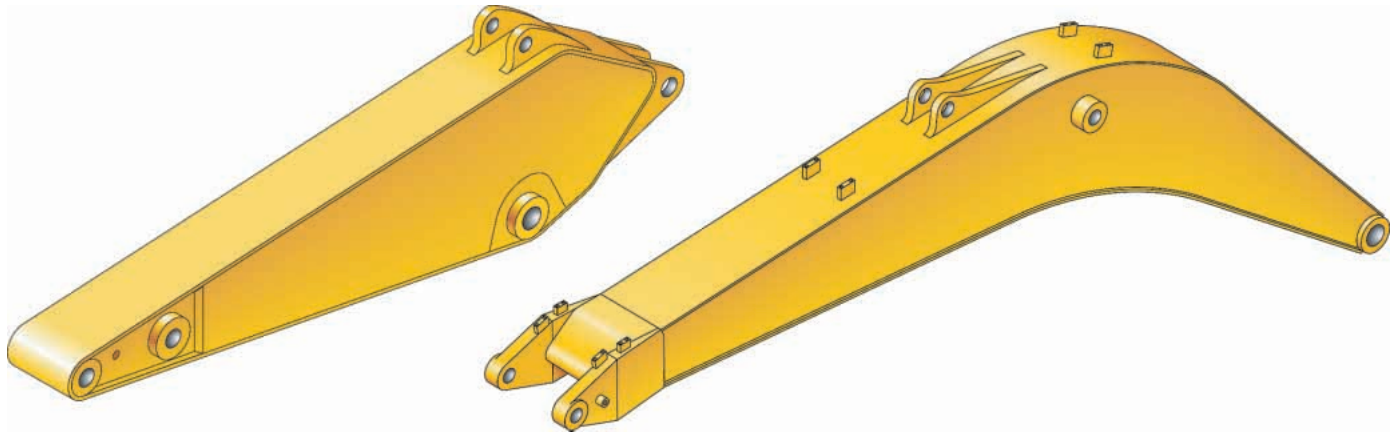

Front Linkage Attachments.

Three length of booms and six types of sticks are available, offering a range of configurations suitable for a wide variety of application conditions.

Boom Construction. The 345C L booms have large cross-sections and internal baffle plates to provide long life durability. Forged steel is used in critical high-load areas such as the boom-foot and boom cylinder connection.

Long Reach Boom – 7.4 m (23 ft 3 in) long. The Long Reach boom is new with the introduction of the 345C L. This boom combined with the new 4.3 m (14 ft 1 in) stick provides a similar digging envelope to the previous 345B. This new boom/stick combination has a significantly reduced transport height, eliminating the need to remove the stick cylinder pin.

Reach Boom – 6.9 m (22 ft 8 in) long.

The Reach boom is designed to balance reach, digging force bucket capacity, offering a wide range of applications as digging, loading and trenching.

Mass Excavation Boom – 6.55 m (21 ft 6 in) long. The mass boom is designed to provide maximum digging forces, bucket capacity and truck loading productivity. The mass boom comes with two stick options for further job site versatility.

Stick Construction. The 345C L sticks are made of high-tensile strength steel, using a large box section design, interior baffle plates and an additional bottom guard.

Linkage Pins. The bucket linkage pins have been enlarged and have a thick chrome plating improving reliability, durability, giving them high wear and corrosion resistance. An adapter kit is available for using 345B II buckets.

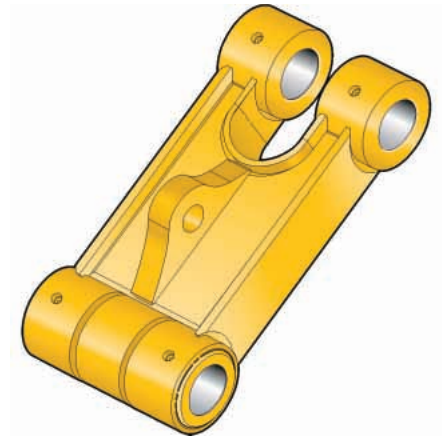

Power Link. The new 345C L power link improves durability, increases machine-lifting capability in key lifting positions, and is easier to use compared to the previous lift bar design.

Work Tools

The 345C L has extensive selection of work tools to optimize machine performance.



Excavation Buckets. Excavation buckets are designed for general purpose excavation, ranging from low or medium friction soft earth to hard earth. The bucket is designed with a large bucket capacity and tip radius.

Extreme Service Excavation Buckets.

These buckets are designed for aggressive bucket loading and digging in abrasive materials. Features include:

- Provides the same wear life as non-extreme service buckets that are used in less abrasive, easy to dig materials.
- Has the same profile as the normal excavation bucket.
- Reinforced with thicker materials for greater wear protection.

V-Type Excavation Buckets. The V-type excavation buckets have a V or spade type cutting edge. This greatly improves penetration in materials that are hard or difficult to load.

Mass Excavation Buckets.

Large capacity for production truck loading in low-impact, moderately abrasive materials such as dirt, loam, gravel and clay.

Service Life. Caterpillar buckets increase service life and reduce repair costs.

- Dual radius design for increased life and reduced wear.
- Robot welding of hinge assembly for increased weld penetration and longer life.
- Incorporates the new aggressive and easier to install, K GET system.
- High strength and heat-treated steel that exceeds T-1 in high wear areas.



Caterpillar Ground Engaging Tools (GET).

The new Caterpillar K-series GET is featured on the new 345C L buckets. This new GET system uses a hammerless vertical retainer, which is easier to remove and install than the old Cat J-series pin. The new tooth shapes are more aggressive and offer excellent penetration. There are a variety of side cutters and sidebar protectors to match operating conditions.

- A new sidecutter design is more aggressive in trenching applications, improving efficiency and bucket payload.



Tool Control System. The optional tool control system maximizes work tool productivity by configuring hydraulic flow, pressure, and operator controls to match a specific work tool. System versatility enables a wide range of tools to be used.

Work Tools. Choose from a variety of work tools such as hammers, shears, pulverizers, compactors, multi-processors, sorting grapples and couplers. Ask your Cat dealer for information on attachments or special configurations.



Multi-Processor



Hammer

Control Levers. The operator's control lever preferences are diverse in much the same way as different tools. Three types of tool controls are available to ensure that the operator's preferences are met.

- Foot pedal – The hydraulic modulated foot pedal is used in conjunction with the hydraulic controller.

Service and Maintenance

Simplified service and maintenance save you time and money.



Extended Service Intervals.

Extended service and maintenance intervals increase machine availability. The maintenance intervals for engine oil and engine oil filter have been extended to 500 hours.

Capsule Filter. The hydraulic return filters are located in the hydraulic tank. The filter elements are removable without spilling hydraulic oil.

Pilot Hydraulic System Filter.

Pilot hydraulic system filter keeps contaminants from the pilot system and is located in the pump compartment.

Radial Seal Main Air Cleaner.

Radial seal main air cleaner with pre-cleaner has a double-layered filter element for more efficient filtration. No tools are required to change the element.

Fuel-Water Separator. The water separator has a primary fuel filter element and is located in the air cleaner compartment for easy access from the ground.

Service Points. Service points are centrally located with easy access to facilitate routine maintenance.



Oil Sample and Pressure Ports.

Oil sample and pressure ports provide easy checking of machine condition and are standard on every machine.

Greasing Points. A concentrated remote greasing block on the boom delivers grease to hard-to-reach locations.

Complete Customer Support

Cat dealer services help you operate longer with lower costs.



Product Support. You will find nearly all parts at our dealer parts counter. Cat dealers utilize a worldwide computer network to find in-stock parts to minimize machine downtime. You can save money with Cat remanufactured components.

Machine Selection. Make detailed comparisons of the machines you are considering before you buy. What are the job requirements, machine attachments and operating hours? What production is needed? Your Cat dealer can provide recommendations.

Purchase. Look past initial price. Consider the financing options available as well as day-to-day operating costs. This is also the time to look at dealer services that can be included in the cost of the machine to yield lower equipment owning and operating costs over the long run.

Customer Support Agreements. Cat dealers offer a variety of product support agreements, and work with customers to develop a plan the best meets specific needs. These plans can cover the entire machine, including attachments, to help protect the customer's investment.

Operation. Improving operating techniques can boost your profits. Your Cat dealer has videotapes, literature and other ideas to help you increase productivity, and Caterpillar offers certified operator training classes to help maximize the return on your investment.

Maintenance Services. Repair option programs guarantee the cost of repairs up front. Diagnostic programs such as Scheduled Oil Sampling, Coolant Sampling and Technical Analysis help you avoid unscheduled repairs.

Replacement. Repair, rebuild or replace? Your Cat Dealer can help you evaluate the cost involved so you can make the right choice.

Engine

Engine Model	Cat C13 ACERT™	
Net Flywheel Power	239 kW	321 hp
ISO 9249	239 kW	321 hp
SAE J1349	239 kW	321 hp
EEC 80/1269	239 kW	321 hp
Bore	130 mm	5.1 in
Stroke	157 mm	6.2 in
Displacement	12.5 L	736 in ³

- The 345C/345C L meets the EU Stage II exhaust emission requirements.
- Net power advertised is the power available at the flywheel when the engine is equipped with fan, air cleaner, muffler and alternator.
- No engine derating needed up to 2300 m (7,500 ft).

Weights

Operating Weight – Long Undercarriage	44 970 kg	99,150 lb
---------------------------------------	-----------	-----------

- Reach Boom, R3.9 (12'10") stick, 1219 mm (48") GP-C Bucket and 750 mm (30") shoes.

Operating Specifications

Maximum Reach at Ground Level	12.96 m	42 ft 6 in
Maximum Digging Depth	8.92 m	29 ft 4 in
Maximum Bucket Capacity	3.8 m ³	5 yd ³
Nominal Bucket Weight	1762 kg	3,880 lb

Track

Number of Shoes Each Side – Long Undercarriage	52
Number of Track Rollers Each Side – Long Undercarriage	9
Number of Carrier Rollers Each Side	2

Swing Mechanism

Swing Speed	8.6 rpm	
Swing Torque	148.5 kN·m	109,560 lb ft

Drive

Maximum Travel Speed	4.4 km/h	2.7 mph
Maximum Drawbar Pull – Long Undercarriage	337.7 kN	75,920 lb

Hydraulic System

Main System – Maximum Flow (Total)	720 L/min	190 gal/min
Maximum Pressure – Equipment – Normal	35 000 kPa	5,080 psi
Maximum Pressure – Equipment – Heavy Lift	36 000 kPa	5,220 psi
Maximum Pressure – Travel	35 000 kPa	5,080 psi
Maximum Pressure – Swing	31 400 kPa	4,550 psi
Pilot System – Maximum Flow	43 L/min	11 gal/min
Pilot System – Maximum Pressure	4110 kPa	596 psi
Boom Cylinder – Bore	160 mm	6.3 in
Boom Cylinder – Stroke	1575 mm	62 in
Stick Cylinder – Bore	190 mm	7.5 in
Stick Cylinder – Stroke (for Long Reach and Reach Fronts)	1778 mm	70 in
Stick Cylinder – Stroke (for Mass Excavation Fronts)	1758 mm	69.2 in
TB Family Bucket Cylinder – Bore	160 mm	6.3 in
TB Family Bucket Cylinder – Stroke	1356 mm	53.4 in
UB Family Bucket Cylinder – Bore	170 mm	6.7 in
UB Family Bucket Cylinder – Stroke	1396 mm	55 in
Main Normal Relief Pressure	35 000 kPa	5,080 psi

Service Refill Capacities

Fuel Tank Capacity	705 L	186 gal
Cooling System	61 L	16 gal
Engine Oil	42 L	11 gal
Swing Drive (each)	10 L	2.6 gal
Final Drive (each)	15 L	4 gal
Hydraulic System (including tank)	570 L	150 gal
Hydraulic Tank	243 L	64 gal

Sound Performance

Performance	ANSI/SAE J1166 MAY90 Meets OSHA and MSHA Requirements
-------------	---

- When properly installed and maintained, the cab offered by Caterpillar, when tested with doors and windows closed according to ANSI/SAE J1166 OCT 98, meets OSHA and MSHA requirements for operator sound exposure limits in effects at time of manufacture.
- Hearing protection may be needed when operating with an open operator station and cab (when not properly maintained or doors/windows open) for extended periods or in noisy environment.

Standards

Brakes	SAE J1026 APR90
Cab/FOGS	SAE J1356 FEB 88 and ISO 10262-1998

345C L Dimensions

All dimensions are approximate.

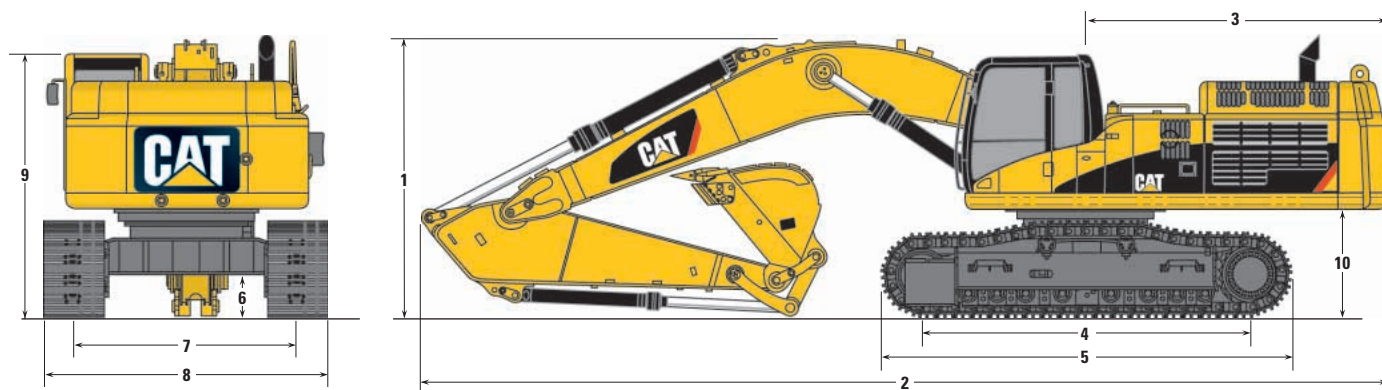

Boom	Long Reach Boom 7.4 m (24'3")			Reach Boom 6.9 m (22'8")		Mass Boom 6.55 m (21'6")	
	R4.3TB (14'1")	R3.9TB (12'10")	R3.9TB (12'10")	R3.35TB (11'0")	R2.9TB (9'6")	M3.0VB (9'10")	M2.5VB (8'2")
1 Shipping Height							
Fixed Gauge Undercarriage	3590 mm (11'9")	3720 mm (12'2")	3830 mm (12'7")	3500 mm (11'6")	3630 mm (11'11")	3970 mm (13'0")	3940 mm (12'11")
Variable Gauge Undercarriage	3600 mm (11'10")	3590 mm (11'9")	3820 mm (12'6")	3490 mm (11'5")	3680 mm (12'1")	3990 mm (13'1")	3980 mm (13'1")
2 Shipping Length							
Fixed Gauge Undercarriage	12 390 mm (40'8")	12 410 mm (40'9")	11 920 mm (39'1")	11 840 mm (38'10")	11 870 mm (38'11")	11 550 mm (37'11")	11 630 mm (38'2")
Variable Gauge Undercarriage	12 340 mm (40'6")	12 340 mm (40'6")	11 910 mm (39'1")	11 780 mm (38'8")	11 850 mm (38'10")	11 520 mm (37'10")	11 540 mm (37'10")
3 Tail Swing Radius	3770 mm (12'4")	3770 mm (12'4")	3770 mm (12'4")	3770 mm (12'4")	3770 mm (12'4")	3770 mm (12'4")	3770 mm (12'4")
Undercarriage							
		Fixed Gauge			Variable Gauge		
4 Length to Center of Rollers		4360 mm (14'4")			4340 mm (14'3")		
5 Track Length		5360 mm (17'7")			5340 mm (17'6")		
6 Ground Clearance		510 mm (1'8")			740 mm (2'5")		
7 Track Gauge							
Retracted (Transport) Position		2740 mm (9'0")			2390 mm (7'10")		
Extended (Working) Position		2740 mm (9'0")			2890 mm (9'6")		
8 Track Width*							
Retracted (Transport) Position		3640 mm (11'11")			3290 mm (10'10")		
Extended (Working) Position		3640 mm (11'11")			3790 mm (12'5")		
9 Cab Height		3210 mm (10'6")			3360 mm (11'0")		
10 Counterweight Height (to bottom)		1280 mm (4'2")			1430 mm (4'8")		

* Track Width shown is for 900 mm (36") track shoes. Subtract 150 mm (6") for 750 mm (30") track shoes

Reach Working Ranges

Reach (R) boom configuration

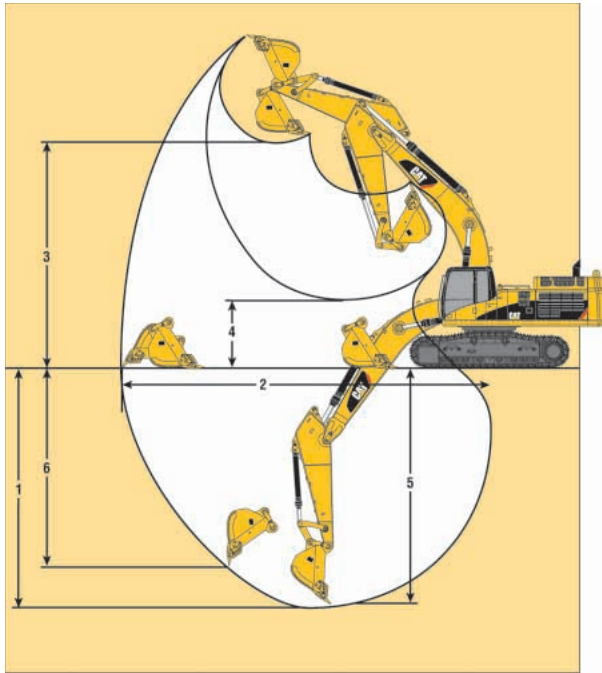

Mass Working Ranges

Mass (M) boom configuration

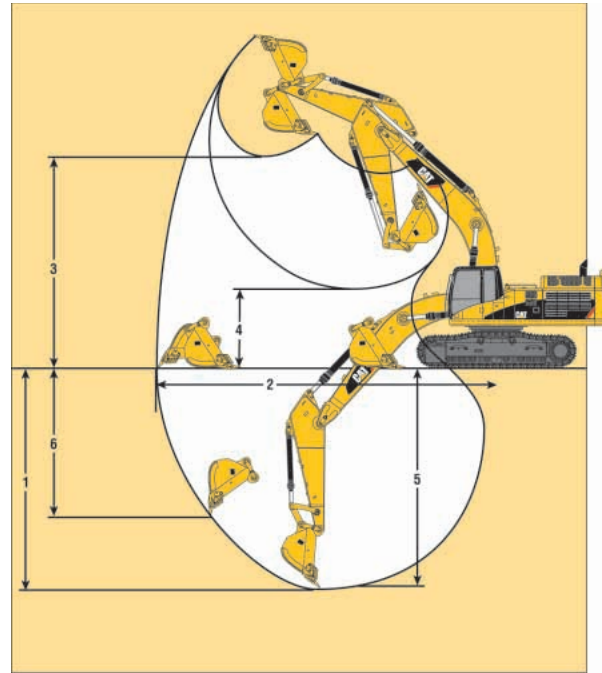

345C Working Ranges – Standard Fixed Gauge Undercarriage

	Long Reach Boom		Reach Boom				Mass Excavation Boom	
	R4.3TB (14'1")	R3.9TB (12'10")	R4.3TB (14'1")	R3.9TB (12'10")	R3.35TB (11'0")	R2.9TB (9'6")	M3.0VB (9'10")	M2.5VB (8'2")
Stick								
Bucket	GP-C 1.9 m ³ (2.46 yd ³)	GP-C 1.9 m ³ (2.46 yd ³)	GP-C 1.9 m ³ (2.46 yd ³)	GP-C 1.9 m ³ (2.46 yd ³)	GP-C 1.9 m ³ (2.46 yd ³)	GP-C 1.9 m ³ (2.46 yd ³)	HD 2.8 m ³ (3.70 yd ³)	HD 2.8 m ³ (3.70 yd ³)
1 Maximum Digging Depth	8920 mm (29'3")	8520 mm (27'11")	8600 mm (28'3")	8200 mm (26'11")	7650 mm (25'1")	7200 mm (23'7")	7250 mm (23'9")	6740 mm (22'2")
2 Maximum Reach at Ground Level	12 960 mm (42'6")	12 600 mm (41'4")	12 520 mm (41'1")	12 150 mm (39'10")	11 710 mm (38'5")	11 290 mm (37'1")	11 200 mm (36'9")	10 740 mm (35'3")
3 Maximum Loading Height	7930 mm (26'0")	7800 mm (25'7")	7590 mm (24'11")	7460 mm (24'6")	7420 mm (24'4")	7240 mm (23'9")	6790 mm (22'3")	6590 mm (21'8")
4 Minimum Loading Height	2240 mm (7'4")	2640 mm (8'8")	1800 mm (5'11")	2200 mm (7'3")	2750 mm (9'0")	3200 mm (10'6")	2630 mm (8'8")	3130 mm (10'3")
5 Maximum Depth Cut for 2440 mm (8') Level Bottom	8790 mm (28'10")	8380 mm (27'6")	8480 mm (27'10")	8070 mm (26'6")	7500 mm (24'7")	7040 mm (23'1")	7100 mm (23'3")	6580 mm (21'7")
6 Maximum Vertical Wall Digging Depth	5960 mm (19'7")	5430 mm (17'10")	5910 mm (19'5")	5400 mm (17'8")	5210 mm (17'1")	4810 mm (15'9")	4910 mm (16'1")	4460 mm (14'8")

345C Working Ranges with Pin Grabber Coupler – Standard Fixed Gauge Undercarriage

	Reach Boom	
	R3.35TB (11'0")	R2.9TB (9'6")
Stick		
Bucket with VB-Family Coupler	GP-C 1.9 m ³ (2.46 yd ³)	GP-C 1.9 m ³ (2.46 yd ³)
1 Maximum Digging Depth	7970 mm (26'2")	7520 mm (24'8")
2 Maximum Reach at Ground Level	12 040 mm (39'6")	11 620 mm (38'2")
3 Maximum Loading Height	7100 mm (23'3")	6920 mm (22'8")
4 Minimum Loading Height	2430 mm (8'0")	2880 mm (9'5")
5 Maximum Depth Cut for 2440 mm (8') Level Bottom	7840 mm (25'9")	7380 mm (24'2")
6 Maximum Vertical Wall Digging Depth	3990 mm (13'1")	3620 mm (11'10")

Reach Working Ranges

Reach (R) boom configuration

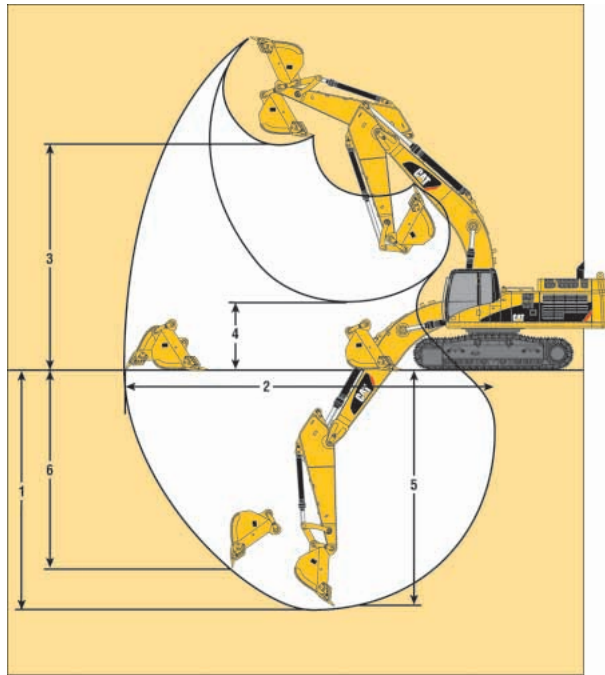

Mass Working Ranges

Mass (M) boom configuration

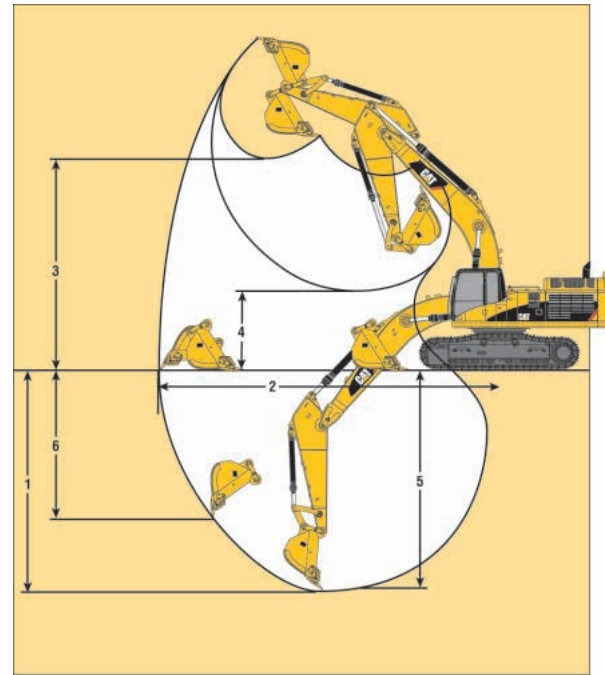

345C L Working Ranges – Long Fixed Gauge Undercarriage

Stick	Long Reach Boom			Reach Boom			Mass Excavation Boom	
	R4.3TB (14'1")	R3.9TB (12'10")	R4.3TB (14'1")	R3.9TB (12'10")	R3.35TB (11'0")	R2.9TB (9'6")	M3.0VB (9'10")	M2.5VB (8'2")
Bucket	GP-C 1.9 m ³ (2.46 yd ³)	GP-C 1.9 m ³ (2.46 yd ³)	GP-C 1.9 m ³ (2.46 yd ³)	GP-C 1.9 m ³ (2.46 yd ³)	GP-C 1.9 m ³ (2.46 yd ³)	GP-C 1.9 m ³ (2.46 yd ³)	HD 2.8 m ³ (3.70 yd ³)	HD 2.8 m ³ (3.70 yd ³)
1 Maximum Digging Depth	8920 mm (29'3")	8520 mm (27'11")	8600 mm (28'3")	8200 mm (26'11")	7650 mm (25'1")	7200 mm (23'7")	7250 mm (23'9")	6740 mm (22'2")
2 Maximum Reach at Ground Level	12 960 mm (42'6")	12 600 mm (41'4")	12 520 mm (41'1")	12 150 mm (39'10")	11 710 mm (38'5")	11 290 mm (37'1")	11 200 mm (36'9")	10 740 mm (35'3")
3 Maximum Loading Height	7930 mm (26'0")	7800 mm (25'7")	7590 mm (24'11")	7460 mm (24'6")	7420 mm (24'4")	7240 mm (23'9")	6790 mm (22'3")	6590 mm (21'8")
4 Minimum Loading Height	2240 mm (7'4")	2640 mm (8'8")	1800 mm (5'11")	2200 mm (7'3")	2750 mm (9'0")	3200 mm (10'6")	2630 mm (8'8")	3130 mm (10'3")
5 Maximum Depth Cut for 2440 mm (8') Level Bottom	8790 mm (28'10")	8380 mm (27'6")	8480 mm (27'10")	8070 mm (26'6")	7500 mm (24'7")	7040 mm (23'1")	7100 mm (23'3")	6580 mm (21'7")
6 Maximum Vertical Wall Digging Depth	5960 mm (19'7")	5430 mm (17'10")	5910 mm (19'5")	5400 mm (17'8")	5210 mm (17'1")	4810 mm (15'9")	4910 mm (16'1")	4460 mm (14'8")

345C L Working Ranges with Pin Grabber Coupler – Long Fixed Gauge Undercarriage

Stick	Reach Boom	
	R3.35TB (11'0")	R2.9TB (9'6")
Bucket with VB-Family Coupler	GP-C 1.9 m³ (2.46 yd³)	GP-C 1.9 m³ (2.46 yd³)
1 Maximum Digging Depth	7970 mm (26'2")	7520 mm (24'8")
2 Maximum Reach at Ground Level	12 040 mm (39'6")	11 620 mm (38'2")
3 Maximum Loading Height	7100 mm (23'3")	6920 mm (22'8")
4 Minimum Loading Height	2430 mm (8'0")	2880 mm (9'5")
5 Maximum Depth Cut for 2440 mm (8') Level Bottom	7840 mm (25'9")	7380 mm (24'2")
6 Maximum Vertical Wall Digging Depth	3990 mm (13'1")	3620 mm (11'10")

Reach Working Ranges

Reach (R) boom configuration

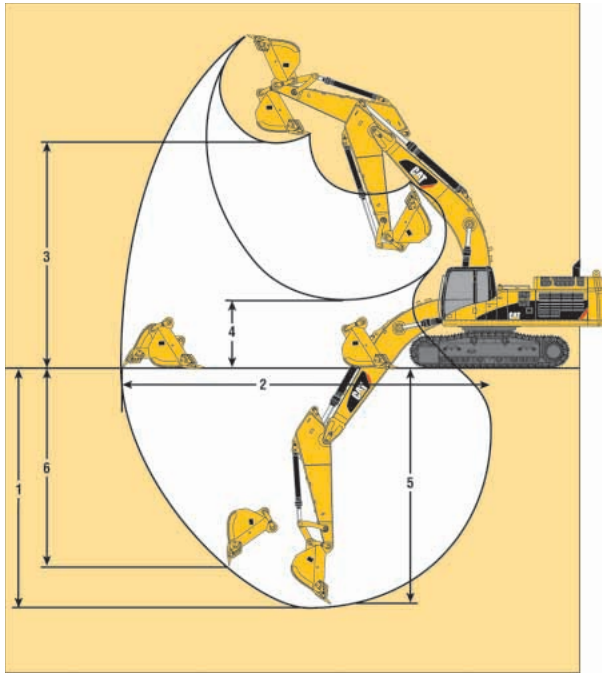

Mass Working Ranges

Mass (M) boom configuration

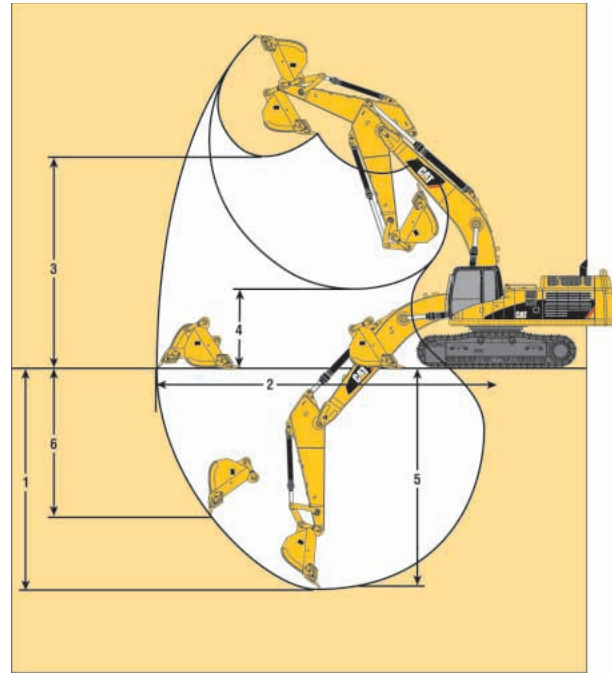

345C L Working Ranges – Long Variable Gauge Undercarriage

	Long Reach Boom		Reach Boom				Mass Excavation Boom	
	R4.3TB (14'1")	R3.9TB (12'10")	R4.3TB (14'1")	R3.9TB (12'10")	R3.35TB (11'0")	R2.9TB (9'6")	M3.0VB (9'10")	M2.5VB (8'2")
Stick								
Bucket	GP-C 1.9 m ³ (2.46 yd ³)	GP-C 1.9 m ³ (2.46 yd ³)	GP-C 1.9 m ³ (2.46 yd ³)	GP-C 1.9 m ³ (2.46 yd ³)	GP-C 1.9 m ³ (2.46 yd ³)	GP-C 1.9 m ³ (2.46 yd ³)	HD 2.8 m ³ (3.70 yd ³)	HD 2.8 m ³ (3.70 yd ³)
1 Maximum Digging Depth	8770 mm (28'9")	8370 mm (27'6")	8450 mm (27'9")	8050 mm (26'5")	7500 mm (24'7")	7050 mm (23'2")	7100 mm (23'4")	6600 mm (21'8")
2 Maximum Reach at Ground Level	12 940 mm (42'5")	12 570 mm (41'3")	12 490 mm (41'0")	12 120 mm (39'9")	11 680 mm (38'4")	11 260 mm (36'11")	11 180 mm (36'8")	10 710 mm (35'2")
3 Maximum Loading Height	8070 mm (26'6")	7940 mm (26'1")	7740 mm (25'5")	7600 mm (24'11")	7570 mm (24'10")	7390 mm (24'3")	6930 mm (22'9")	6740 mm (22'1")
4 Minimum Loading Height	2380 mm (7'10")	2780 mm (9'1")	1950 mm (6'5")	2350 mm (7'9")	2900 mm (9'6")	3350 mm (11'0")	2780 mm (9'1")	3280 mm (10'9")
5 Maximum Depth Cut for 2440 mm (8') Level Bottom	8650 mm (28'4")	8240 mm (27'0")	8330 mm (27'4")	7920 mm (26'0")	7360 mm (24'2")	6900 mm (22'8")	6950 mm (22'10")	6430 mm (21'1")
6 Maximum Vertical Wall Digging Depth	5810 mm (19'1")	5290 mm (17'4")	5770 mm (18'11")	5250 mm (17'3")	5070 mm (16'7")	4670 mm (15'4")	4770 mm (15'8")	4310 mm (14'2")

345C L Working Ranges with Pin Grabber Coupler – Long Variable Gauge Undercarriage

	Reach Boom	
	R3.35TB (11'0")	R2.9TB (9'6")
Stick		
Bucket with VB-Family Coupler	GP-C 1.9 m ³ (2.46 yd ³)	GP-C 1.9 m ³ (GP-C 2.46 yd ³)
1 Maximum Digging Depth	7830 mm (25'8")	7380 mm (24'3")
2 Maximum Reach at Ground Level	12 010 mm (39'4")	11 590 mm (38'0")
3 Maximum Loading Height	7240 mm (23'9")	7060 mm (23'2")
4 Minimum Loading Height	2570 mm (8'5")	3020 mm (9'11")
5 Maximum Depth Cut for 2440 mm (8') Level Bottom	7690 mm (25'3")	7230 mm (23'9")
6 Maximum Vertical Wall Digging Depth	3840 mm (12'7")	3470 mm (11'5")

Operating Weight*

	kg	lb		kg	lb
Complete machine equipped with:			Differences for other buckets:		
6.9 m (22'8") reach boom, R3.9m (12'10") stick, 1219 mm (48") GP-C bucket, long fixed gauge undercarriage with 750 mm (30") TG track shoes, 7610 kg (16,780 lb) counterweight without removal device	44 970	99,150	See bucket specification chart		
Differences for other booms:			Differences for other undercarriages:		
7.4 m (24'3") long reach boom	+180	+400	STD fixed undercarriage**	-610	-1,360
6.9 m (22'8") heavy duty reach boom	+515	+1,130	Long variable gauge undercarriage***	+2195	+4,840
6.55 m (21'6") mass excavation boom	+520	+1,150	Differences for other track shoes:		
Differences for other sticks:			600 mm (24") double grouser (DG)	-645	-1,420
R4.3m (14'1") stick with TB bucket linkage and bucket cylinder	+110	+245	750 mm (30") single grouser (SG)	-110	-250
R3.35m (11'0") stick with TB bucket linkage and bucket cylinder	-110	-245	750 mm (30") double grouser (DG)	+140	+305
R2.9m (9'6") stick with TB bucket linkage and bucket cylinder	-105	-230	900 mm (36") double grouser (DG)	+920	+2,030
M3.0m (9'10") stick with VB bucket linkage and bucket cylinder	+320	+705	900 mm (36") triple grouser (TG)	+750	+1,660
M2.5m (8'2") stick with VB bucket linkage and bucket cylinder	+140	+310	Differences for other counterweights:		
			8.0 MT counterweight without removal device	+500	+1,100
			9.0 MT counterweight without removal device	+1400	+3,080
			Counterweight removal device	+315	+690

* Operating weight includes full fuel tank and 75 kg (165 lb) operator. Subtract 380 kg (840 lb) for 50% fuel and no operator.

** APD offers not only 345C L but also 345C.

*** APD will offer Long VG undercarriage with H/D upper frame (+405 kg).

Bucket Specifications

345C (Standard Undercarriage) and 345C L (Long Undercarriage)

Contact your Caterpillar dealer for special bucket requirements.

TB Buckets for Reach Linkage	Capacity*		Width		Tip Radius		Weight (without tips)		Teeth Qty	345C – Reach Boom Stick			345C L – Reach Boom Stick		
	m ³	yd ³	mm	in	mm	in	kg	lb		R3.9TB (12'10")	R3.35TB (11'0")	R2.9TB (9'6")	R3.9TB (12'10")	R3.35TB (11'0")	R2.9TB (9'6")
	Excavation	1.6	2.09	1067	42	1869	73.6	1616	3,560	4	☐	●	●	☐	●
	1.9	2.46	1219	48	1869	73.6	1762	3,880	5	○	☐	●	○	●	●
	2.0	2.62	1590	63	1870	73.6	1700	3,740	6	☐	●	●	●	●	●
	2.2	2.88	1735	68	1870	73.6	1810	3,990	6	○	☐	●	☐	☐	●
Extreme Service Excavation	1.9	2.50	1560	61	1862	73.3	1825	4,020	5	☐	●	●	●	●	●
	2.0	2.62	1605	63	1862	73.3	1870	4,120	5	☐	●	●	☐	●	●
	2.1	2.75	1665	66	1862	73.3	1915	4,220	5	☐	☐	●	☐	●	●

VB Buckets for Mass EX Linkage	Capacity*		Width		Tip Radius		Weight (without tips)		Teeth Qty	345C – Mass Boom Stick		345C L – Mass Boom Stick	
	m ³	yd ³	mm	in	mm	in	kg	lb		M3.0VB (9'10")	M2.5VB (8'2")	M3.0VB (9'10")	M2.5VB (8'2")
Excavation	2.1	2.75	1360	54	2020	79.5	1900	4,189	5	☐	●	●	●
Mass Excavation	2.6	3.50	1895	75	1958	77.1	2320	5,110	6	∴	○	☐	☐
V-Type Excavation	2.1	2.75	1830	72	1860	73.2	2235	4,920	6	☐	●	●	●
	2.2	2.88	1750	69	1958	77.1	2400	5,280	6	○	☐	●	●
	2.4	3.00	1880	74	1958	77.1	2500	5,510	6	○	☐	☐	●

Assumptions for maximum material density rating:

1. Front linkage fully extended at ground line
2. Bucket curled
3. 100% bucket fill factor

* Based on SAE J296, some calculations of capacity specs fall on borderlines.

Rounding may allow two buckets to have the same English rating, but different metric ratings.

- 2100 kg/m³ (3,500 lb/yd³) max material density
- ☐ 1800 kg/m³ (3,000 lb/yd³) max material density
- 1500 kg/m³ (2,500 lb/yd³) max material density
- ∴ 1200 kg/m³ (2,000 lb/yd³) max material density

345C/345C L Bucket and Stick Forces

Stick Forces									
TB-Family Buckets	Sticks								
	R4.3		R3.9		R3.35		R2.9		
	kN	lb	kN	lb	kN	lb	kN	lb	
GP-C, HD, HDR									
Stick Digging Force (ISO)	173	38,800	186	41,800	201	45,100	221	49,600	
Stick Digging Force (SAE)	169	37,900	181	40,800	195	43,900	214	48,000	
HD-P									
Stick Digging Force (ISO)	178	39,900	191	43,000	207	46,600	229	51,400	
Stick Digging Force (SAE)	173	38,800	186	41,800	201	45,100	220	49,500	
GP-C, HD, HDR with coupler									
Stick Digging Force (ISO)	163	36,600	175	39,300	187	42,100	205	46,000	
Stick Digging Force (SAE)	160	36,000	172	38,700	184	41,300	200	45,000	
HD-P with coupler									
Stick Digging Force (ISO)	167	37,500	179	40,300	193	43,300	211	47,400	
Stick Digging Force (SAE)	164	36,800	176	39,500	188	42,400	206	46,200	

VB-Family Buckets	Sticks			
	M3.0		M2.5	
	kN	lb	kN	lb
GP				
Stick Digging Force (ISO)	207	46,400	234	52,500
Stick Digging Force (SAE)	199	44,700	224	50,300
HD, HDR with coupler				
Stick Digging Force (ISO)	210	47,300	238	53,600
Stick Digging Force (SAE)	203	45,500	228	51,300

	Bucket Forces			
	TB-Family Buckets		VB-Family Buckets	
	kN	lb	kN	lb
GP-C, HD, HDR				
Bucket Digging Force (ISO)	268	60,200	279	62,700
Bucket Digging Force (SAE)	238	53,500	248	55,700
HD-P				
Bucket Digging Force (ISO)	300	67,300	293	65,800
Bucket Digging Force (SAE)	258	58,000	259	58,300
GP-C, HD, HDR with coupler				
Bucket Digging Force (ISO)	220	49,400		
Bucket Digging Force (SAE)	203	45,600		
HD-P with coupler				
Bucket Digging Force (ISO)	239	53,700		
Bucket Digging Force (SAE)	217	48,700		

Reach Boom Lift Capacities



Load Point Height



Load at Maximum Reach



Load Radius Over Front



Load Radius Over Side

BOOM – 6.9 m (22'8")
STICK – 3.9 m (12'10")

BUCKET – 1.6 m³ (2.09 yd³)
SHOES – 600 mm (23.62") triple grouser

UNDERCARRIAGE – Standard gauge
COUNTERWEIGHT – 8 ton (17,637 lb)

Load Point Height	1.5 m/5.0 ft		3.0 m/10.0 ft		4.5 m/15.0 ft		6.0 m/20.0 ft		7.5 m/25.0 ft		9.0 m/30.0 ft		10.5 m/35.0 ft		m ft				
	Over Front	Over Side	Over Front	Over Side	Over Front	Over Side	Over Front	Over Side	Over Front	Over Side	Over Front	Over Side	Over Front	Over Side	kg	lb			
9.0 m 30.0 ft															*4200	*4200	9.90		
7.5 m 25.0 ft											*7150	6450			*4100	*4100	10.83		
6.0 m 20.0 ft											*14,100	13,700			*8,950	*8,950	35.33		
4.5 m 15.0 ft											*7850	6350			*4100	3900	11.44		
3.0 m 10.0 ft											*17,200	13,550			*8,950	*8,700	37.42		
1.5 m 5.0 ft											*9400	8600	*8400	6150	*6150	4450	*4200	3550	11.78
Ground Line			*8650	*8650	*23 000	15 700	*16 300	10 100	11 350	7150	8450	5300	6550	4050	*5400	3450	11.44		
-1.5 m -5.0 ft	*9250	*9250	*13 300	*13 300	*23 000	15 350	15 900	9800	11 100	6900	8300	5150			6200	3800	10.85		
-3.0 m -10.0 ft	*14 200	*14 200	*19 000	*19 000	*21 800	15 400	15 800	9700	11 000	6850	8300	5150			7200	4500	9.96		
-4.5 m -15.0 ft			*23 100	*23 100	*19 300	15 700	*14 550	9800	11 150	6950					*6450	5850	8.67		
-6.0 m -20.0 ft			*20 150	*20 150	*15 050	*15 050	*11 300	10 250							*8800	8050	7.04		
			*42,700	*42,700	*31,900	*31,900	*23,700	22,050							*19,250	18,250	22.72		

BOOM – 6.9 m (22'8")
STICK – 3.9 m (12'10")

BUCKET – 1.6 m³ (2.09 yd³)
SHOES – 600 mm (23.62") triple grouser

UNDERCARRIAGE – Long – fixed gauge
COUNTERWEIGHT – 8 ton (17,637 lb)

Load Point Height	1.5 m/5.0 ft		3.0 m/10.0 ft		4.5 m/15.0 ft		6.0 m/20.0 ft		7.5 m/25.0 ft		9.0 m/30.0 ft		10.5 m/35.0 ft		m ft				
	Over Front	Over Side	Over Front	Over Side	Over Front	Over Side	Over Front	Over Side	Over Front	Over Side	Over Front	Over Side	Over Front	Over Side	kg	lb			
9.0 m 30.0 ft															*4200	*4200	9.90		
7.5 m 25.0 ft											*7150	6550			*4100	*4100	10.83		
6.0 m 20.0 ft											*14,100	13,900			*8,950	*8,950	35.33		
4.5 m 15.0 ft											*7850	6450			*4100	4000	11.44		
3.0 m 10.0 ft											*17,200	13,800			*8,950	*8,850	37.42		
1.5 m 5.0 ft											*9400	8750	*8400	6250	*6150	4500	*4200	3650	11.78
Ground Line			*8650	*8650	*23 000	16 000	*16 300	10 300	*12 500	7300	9650	5400	7450	4100	*5400	3550	11.44		
-1.5 m -5.0 ft	*9250	*9250	*13 300	*13 300	*23 000	15 650	*16 650	9950	12 650	7050	9450	5250			6250	3900	10.85		
-3.0 m -10.0 ft	*14 200	*14 200	*19 000	*19 000	*21 800	15 650	*16 150	9850	*12 500	7000	9450	5250			*7600	4600	9.96		
-4.5 m -15.0 ft			*23 100	*23 100	*19 300	15 950	*14 550	10 000	*11 150	7100					*6450	5950	8.67		
-6.0 m -20.0 ft			*20 150	*20 150	*15 050	*15 050	*11 300	10 400							*8800	8200	7.04		
			*42,700	*42,700	*31,900	*31,900	*23,700	22,450							*19,250	18,550	22.72		

* Limited to hydraulic capacity rather than tipping load. The above loads are in compliance with hydraulic excavator lift capacity rating standard SAE J/ISO 10567. They do not exceed 87% of hydraulic lifting capacity or 75% of tipping capacity.

All lifts with heavy lift on.

Reach Boom Lift Capacities



Load Point Height



Load at Maximum Reach



Load Radius Over Front

















Load Radius Over Side

BOOM – 6.9 m (22'8")
STICK – 3.4 m (11'2")

BUCKET – 1.9 m³ (2.49 yd³)
SHOES – 600 mm (23.62") triple grouser















UNDERCARRIAGE – Standard gauge
COUNTERWEIGHT – 8 ton (17,637 lb)

	3.0 m/10.0 ft		4.5 m/15.0 ft		6.0 m/20.0 ft		7.5 m/25.0 ft		9.0 m/30.0 ft				m ft	
														
9.0 m 30.0 ft	kg lb											*4350 *9,600	*4350 *9,600	9.35 30.30
7.5 m 25.0 ft	kg lb											*4150 *9,150	*4150 *9,150	10.34 33.72
6.0 m 20.0 ft	kg lb							*9000 *19,600	8800 18,850	*8400 *18,350	6150 13,100	*4150 *9,100	4150 *9,100	10.98 35.93
4.5 m 15.0 ft	kg lb				*11 900 *25,650	*11 900 *25,650	*10 000 *21,650	8400 18,000	*8850 *19,200	5950 12,750	*4250 *9,350	3750 8,250	11.34 37.18	
3.0 m 10.0 ft	kg lb		*19 600 *42,000	17 800 38,350	*13 950 *30,000	11 350 24,450	*11 100 *24,000	7900 16,950	8900 19,100	5700 12,250	*4500 *9,850	3550 7,800	11.46 37.60	
1.5 m 5.0 ft	kg lb		*21 900 *48,300	16 200 34,950	*15 650 *33,750	10 550 22,700	11 650 25,050	7450 16,000	8650 18,500	5450 11,700	*4850 *10,650	3550 7,750	11.35 37.24	
Ground Line	kg lb	*16,100 *16,100	*20 800 *48,300	15 550 33,350	16 150 34,700	10 000 21,500	11 300 24,250	7100 15,250	8400 18,050	5250 11,250	*5400 *11,900	3700 8,150	10.99 36.06	
-1.5 m -5.0 ft	kg lb	*13 300 *30,000	*13 300 *30,000	*22 600 *49,000	15 400 33,000	15 900 34,100	9750 20,950	11 100 23,800	6900 14,850	5150 11,050	*6300 *13,850	4150 9,100	10.37 33.98	
-3.0 m -10.0 ft	kg lb	*20 200 *45,600	*20 200 *45,600	*20 900 *45,250	15 550 33,350	*15 750 *34,000	9750 20,950	11 050 23,800	6900 14,800	5200	*7600 *16,700	4950 11,000	9.42 30.80	
-4.5 m -15.0 ft	kg lb	*22 650 *50,500	*22 650 *50,500	*17 900 *38,500	15 950 34,250	*13 650 *29,250	10000 21,500	*10 200 *21,550	7100 15,300		*6150 *13,550	*6150 *13,550	8.04 26.11	
-6.0 m -20.0 ft	kg lb			*12 750 *26,750	*12 750 *26,750	*9300 *18,900	*9300 *18,900				*8350 *18,100	*8350 *18,100	6.35 20.42	

BOOM – 6.9 m (22'8")
STICK – 3.4 m (11'2")

BUCKET – 2 m³ (2.62 yd³)
SHOES – 600 mm (23.62") triple grouser

UNDERCARRIAGE – Long – fixed gauge
COUNTERWEIGHT – 8 ton (17,637 lb)

	3.0 m/10.0 ft		4.5 m/15.0 ft		6.0 m/20.0 ft		7.5 m/25.0 ft		9.0 m/30.0 ft				m ft	
														
9.0 m 30.0 ft	kg lb											*4350 *9,600	*4350 *9,600	9.35 30.30
7.5 m 25.0 ft	kg lb											*4200 *9,200	*4200 *9,200	10.34 33.72
6.0 m 20.0 ft	kg lb							*9050 *19,650	8950 19,150	*8400 *18,350	6250 13,350	*4150 *9150	*4150 *9,150	10.98 35.93
4.5 m 15.0 ft	kg lb				*11 900 *25,650	*11 900 *25,650	*10 000 *21,650	8550 18,300	*8850 *19,250	6100 13,000	*4300 *9400	3850 8,450	11.34 37.18	
3.0 m 10.0 ft	kg lb		*19 600 *42,050	18 050 38,950	*13 950 *30,050	11 550 24,850	*11 100 *24,050	8050 17,250	*9450 *20,500	5850 12,500	*4500 *9900	3650 8,000	11.46 37.60	
1.5 m 5.0 ft	kg lb		*21 900 *48,350	16 500 35,550	*15 650 *33,750	10 750 23,100	*12 100 *26,200	7600 16,300	9800 21,000	5600 11,950	*4900 *10,700	3650 7,950	11.35 37.24	
Ground Line	kg lb	*16,100 *16,100	*20 800 *48,300	15 800 34,000	*16 600 *35,850	10 200 21,900	*12 750 *27,550	7250 15,550	9600 20,550	5400 11,500	*5450 *11,950	3800 8,350	10.99 36.06	
-1.5 m -5.0 ft	kg lb	*13 300 *30,000	*13 300 *30,000	*22 650 *49,050	15 650 33,600	*16 650 *36,000	9950 21,350	12 650 27,150	7050 15,150	9450 20,350	*6300 *13,900	4250 9,300	10.37 33.98	
-3.0 m -10.0 ft	kg lb	*20 200 *45,600	*20 200 *45,600	*20 950 *45,300	15 800 33,950	*15 750 *34,050	9950 21,350	*12 200 *26,200	7050 15,100	*9250	*7600 *16,750	5100 11,250	9.42 30.80	
-4.5 m -15.0 ft	kg lb	*22 650 *50,450	*22 650 *50,450	*17 900 *38,550	16 200 34,850	*13 700 *29,300	10 150 21,900	*10 250 *21,550	7250 15,600		*6200 *13,600	*6200 *13,600	8.04 26.11	
-6.0 m -20.0 ft	kg lb			*12 750 *26,750	*12 750 *26,750	*9300 *18,950	*9300 *18,950				*8350 *18,150	*8350 *18,150	6.35 20.42	

* Limited to hydraulic capacity rather than tipping load. The above loads are in compliance with hydraulic excavator lift capacity rating standard SAE J/ISO 10567. They do not exceed 87% of hydraulic lifting capacity or 75% of tipping capacity.

All lifts with heavy lift on.

Reach Boom Lift Capacities



Load Point Height



Load at Maximum Reach



Load Radius Over Front

















Load Radius Over Side

BOOM – 6.9 m (22'8")
STICK – 2.9 m (9'7")

BUCKET – 2 m³ (2.62 yd³)
SHOES – 600 mm (23.62") triple grouser















UNDERCARRIAGE – Standard gauge
COUNTERWEIGHT – 8 ton (17,637 lb)

	3.0 m/10.0 ft		4.5 m/15.0 ft		6.0 m/20.0 ft		7.5 m/25.0 ft		9.0 m/30.0 ft				m ft	
														
9.0 m 30.0 ft	kg lb											*5150 *11,350	*5150 *11,350	8.82 28.52
7.5 m 25.0 ft	kg lb						*9050 *19,800	8800 18,850				*4950 *10,850	*4950 *10,850	9.88 32.18
6.0 m 20.0 ft	kg lb						*9550 *20,750	8600 18,450	*8850 *16,250	6000 12,750		*4900 *10,800	4450 9,900	10.55 34.50
4.5 m 15.0 ft	kg lb			*16 650 *35,650	*16 650 *35,650	*12 550 *27,050	12 000 25,850	*10 450 *22,600	8200 17,650	9050 19,350	5850 12,500	*5050 *11,050	4000 8,800	10.93 35.81
3.0 m 10.0 ft	kg lb			*20 600 *44,200	17 050 36,850	*14 450 *31,150	11 050 23,800	*11 450 *24,750	7750 16,600	8800 18,850	5600 12,000	*5300 *11,650	3800 8,300	11.05 36.25
1.5 m 5.0 ft	kg lb			*17 700 *42,500	15 700 33,800	*15 950 *34,400	10 300 22,150	*11 500 *24,750	7300 15,700	8550 18,300	5400 11,500	*5700 *12,550	3750 8,300	10.93 35.87
Ground Line	kg lb			*19 800 *46,050	15 250 32,750	15 950 34,300	9800 21,100	11 200 24,000	7000 15,000	8350 17,950	5200 11,150	*6350 *14,000	4000 8,750	10.56 34.64
-1.5 m -5.0 ft	kg lb	*13 900 *31,400	*13 900 *31,400	*21 900 *47,500	15 250 32,700	15 800 33,850	9650 20,750	11 050 23,700	6850 14,700	8300 17,850	5150 11,050	7200 15,900	4500 9,500	9.90 32.45
-3.0 m -10.0 ft	kg lb	*20 550 *45,400	*20 550 *45,400	*19 850 *42,950	15 500 33,250	*15 200 *32,800	9750 20,900	11 100 23,800	6900 14,850			*7650 *16,850	5500 12,200	8.90 29.08
-4.5 m -15.0 ft	kg lb	*20 950 *45,100	*20 950 *45,100	*16 400 *35,200	16 000 34,400	*12 650 *26,950	10 050 21,650					*6350 *13,900	*6350 *13,900	7.44 24.22

BOOM – 6.9 m (22'8")
STICK – 2.9 m (9'7")

BUCKET – 2.2 m³ (2.88 yd³)
SHOES – 600 mm (23.62") triple grouser

UNDERCARRIAGE – Long – fixed gauge
COUNTERWEIGHT – 8 ton (17,637 lb)

	3.0 m/10.0 ft		4.5 m/15.0 ft		6.0 m/20.0 ft		7.5 m/25.0 ft		9.0 m/30.0 ft				m ft	
														
9.0 m 30.0 ft	kg lb											*5100 *11,250	*5100 *11,250	8.82 28.52
7.5 m 25.0 ft	kg lb						*9000 *19,700	8900 19,000				*4850 *10,750	*4850 *10,750	9.88 32.18
6.0 m 20.0 ft	kg lb						*9500 *20,600	8700 18,650	*8800 *16,150	6050 12,900		*4850 *10,650	4500 9,950	10.55 34.50
4.5 m 15.0 ft	kg lb			*16 600 *35,600	*16 600 *35,600	*12 500 *26,950	12 150 26,150	*10 400 *22,500	8300 17,850	*9150 *19,850	5900 12,600	*5000 *10,950	4050 8,900	10.93 35.81
3.0 m 10.0 ft	kg lb			*20 550 *44,100	17 300 37,300	*14 400 *31,050	11 200 24,100	*11 400 *24,650	7850 16,800	*9650 *20,900	5700 12,150	*5250 *11,500	3800 8,400	11.05 36.25
1.5 m 5.0 ft	kg lb			*17 650 *42,350	15 900 34,250	*15 900 *34,300	10 400 22,400	*12 250 *26,550	7400 15,900	9650 20,750	5450 11,650	*5650 *12,450	3800 8,350	10.93 35.87
Ground Line	kg lb			*19 750 *45,900	15 450 33,200	*16 550 *35,800	9950 21,400	12 700 27,300	7100 15,200	9500 20,350	5300 11,300	*6300 *13,900	4000 8,850	10.56 34.64
-1.5 m -5.0 ft	kg lb	*13 850 *31,300	*13 850 *31,300	*21 850 *47,350	15 450 33,150	*16 350 *35,300	9800 21,000	12 550 26,950	6950 14,900	9400 20,250	5250 11,200	*7300 *16,150	4550 9,950	9.90 32.45
-3.0 m -10.0 ft	kg lb	*20 550 *45,450	*20 550 *45,450	*19 800 *42,850	15 700 33,700	*15 150 *32,650	9850 21,200	*11 650 *25,050	7000 15,050			*7600 *16,700	5550 12,300	8.90 29.08
-4.5 m -15.0 ft	kg lb	*20 850 *44,950	*20 850 *44,950	*16 350 *35,100	16 250 34,850	*12 600 *26,850	10 200 21,950					*6300 *13,800	*6300 *13,800	7.44 24.22

* Limited to hydraulic capacity rather than tipping load. The above loads are in compliance with hydraulic excavator lift capacity rating standard SAE J/ISO 10567. They do not exceed 87% of hydraulic lifting capacity or 75% of tipping capacity.

All lifts with heavy lift on.

Mass Boom Lift Capacities



Load Point Height



Load at Maximum Reach



Load Radius Over Front

















Load Radius Over Side

BOOM – 6.55 m (21'6")
STICK – 3 m (9'11")

BUCKET – 2.1 m³ (2.75 yd³)
SHOES – 600 mm (23.62") triple grouser















UNDERCARRIAGE – Standard gauge
COUNTERWEIGHT – 8 ton (17,637 lb)

	3.0 m/10.0 ft		4.5 m/15.0 ft		6.0 m/20.0 ft		7.5 m/25.0 ft		9.0 m/30.0 ft				m ft	
														
9.0 m 30.0 ft	kg lb											*4650 *4650	8.70	
7.5 m 25.0 ft	kg lb						*8550 *18,800	8450 17,900				*4400 *9,750	*4400 *9,750	9.79 31.88
6.0 m 20.0 ft	kg lb						*8950 *19,450	8300 17,700	*6750	5500		*4400 *9,650	4100 9,150	10.47 34.23
4.5 m 15.0 ft	kg lb					*11 700 *25,200	*11 700 *25,200	*9800 *21,200	7900 16,950	*8650 18,450	5400 11,500	*4500 *9,900	3650 8,000	10.84 35.53
3.0 m 10.0 ft	kg lb			*19 050 *40,900	17 400 37,550	*13 550 *29,250	10 950 23,550	*10 800 *23,300	7450 15,900	8400 17,950	5200 11,050	*4800 *10,450	3400 7,500	10.95 35.93
1.5 m 5.0 ft	kg lb			*21 650 *46,700	15 650 33,750	*15 100 *32,650	10 050 21,600	11 250 24,100	6950 14,900	8150 17,450	4950 10,550	*5200 *11,450	3400 7,450	10.81 35.47
Ground Line	kg lb			*22 350 *48,350	14 900 31,950	15 700 33,700	9450 20,350	10 850 23,250	6600 14,150	7950 17,000	4750 10,150	*5900 *12,950	3600 7,950	10.40 34.11
-1.5 m -5.0 ft	kg lb	*14 950 *33,850	*14 950 *33,850	*21 600 *46,750	14 700 31,550	15 400 33,050	9200 19,800	10 650 22,850	6400 13,750	7900	4700	*6950 *15,300	4200 9,200	9.69 31.76
-3.0 m -10.0 ft	kg lb	*23 600 *53,450	*23 600 *53,450	*19 600 *42,350	14 950 32,050	*14 650 *31,550	9250 19,850	10 700 22,950	6450 13,850			*7050 *15,450	5350 11,900	8.61 28.11
-4.5 m -15.0 ft	kg lb	*21 150 *45,400	*21 150 *45,400	*15 950 *34,200	15 500 33,250	*11 900 *25,250	9600 20,650					*5950 *19,450	*5950 16,450	7.11 23.22

BOOM – 6.55 m (21'6")
STICK – 3 m (9'11")

BUCKET – 2.2 m³ (2.88 yd³)
SHOES – 600 mm (23.62") triple grouser

UNDERCARRIAGE – Long – fixed gauge
COUNTERWEIGHT – 8 ton (17,637 lb)

	3.0 m/10.0 ft		4.5 m/15.0 ft		6.0 m/20.0 ft		7.5 m/25.0 ft		9.0 m/30.0 ft				m ft	
														
9.0 m 30.0 ft	kg lb											*4750 *4750	8.70	
7.5 m 25.0 ft	kg lb						*8650 *19,000	8650 18,350				*4550 *10,000	*4550 *10,000	9.79 31.88
6.0 m 20.0 ft	kg lb						*9050 *19,650	8500 18,150	*6800	5700		*4500 *9,900	4300 9,550	10.47 34.23
4.5 m 15.0 ft	kg lb					*11 750 *25,350	*11 750 *25,350	*9850 *21,350	8100 17,400	*8750 *19,050	5600 11,850	*4600 *10,150	3800 8,400	10.84 35.53
3.0 m 10.0 ft	kg lb			*19 150 *41,100	17 750 38,300	*13 650 *29,400	11 200 24,050	*10 850 *23,500	7650 16,350	*9200 *20,000	5350 11,450	*4900 *10,700	3600 7,900	10.95 35.93
1.5 m 5.0 ft	kg lb			*21 800 *46,950	16 050 34,500	*15 200 *32,850	10 300 22,150	*11 750 *25,400	7150 15,350	9400 20,100	5150 10,950	*5300 *11,700	3550 7,850	10.81 35.47
Ground Line	kg lb			*22 450 *48,600	15 250 32,750	*16 000 *34,650	9750 20,900	*12 250 *26,500	6800 14,550	9200 19,700	4950 10,550	*6000 *13,200	3800 8,350	10.40 34.11
-1.5 m -5.0 ft	kg lb	*15 050 *34,000	*15 050 *34,000	*21 700 *47,050	15 100 32,350	*15 900 *34,400	9500 20,350	*12 150 *26,250	6600 14,200	9100	4900	*7050 *15,550	4400 9,650	9.69 31.76
-3.0 m -10.0 ft	kg lb	*23 700 *53,650	*23 700 *53,650	*19 700 *42,600	15 300 32,800	*14 750 *31,800	9500 20,400	*11 150 *23,800	6650 14,300			*7150 *15,700	5550 12,350	8.61 28.11
-4.5 m -15.0 ft	kg lb	*21 250 *45,650	*21 250 *45,650	*16 050 *34,400	15 850 34,000	*12 000 *25,450	9850 21,200					*6050 *19,600	*6050 16,900	7.11 23.22

* Limited to hydraulic capacity rather than tipping load. The above loads are in compliance with hydraulic excavator lift capacity rating standard SAE J/ISO 10567. They do not exceed 87% of hydraulic lifting capacity or 75% of tipping capacity. All lifts with heavy lift on.

Mass Boom Lift Capacities



Load Point Height



Load at Maximum Reach



Load Radius Over Front

















Load Radius Over Side

BOOM – 6.55 m (21'6")
STICK – 2.5 m (8'3")

BUCKET – 2.4 m³ (3.14 yd³)
SHOES – 600 mm (23.62") triple grouser















UNDERCARRIAGE – Standard gauge
COUNTERWEIGHT – 8 ton (17,637 lb)

	3.0 m/10.0 ft		4.5 m/15.0 ft		6.0 m/20.0 ft		7.5 m/25.0 ft		9.0 m/30.0 ft				m ft	
														
7.5 m 25.0 ft	kg lb						*9400 8250				*5850 *12,900	5650 12,750	9.26 30.14	
6.0 m 20.0 ft	kg lb						*9700 *21,100	8200 17,450			*5800 *12,800	4650 10,300	9.99 32.65	
4.5 m 15.0 ft	kg lb			*16 700 *35,800	*16 700 *35,800	*12 600 *27,150	11 750 25,250	*10 450 *22,600	7850 16,800	8600 5350	*5950 *13,100	4100 9,000	10.38 34.03	
3.0 m 10.0 ft	kg lb			*20 400 *43,800	16 850 36,350	*14 350 *30,950	10 800 23,250	*11 350 *24,550	7400 15,850	8400 17,950	5200 11,050	*6300 *13,800	3850 8,400	10.50 34.44
1.5 m 5.0 ft	kg lb			*20 000 *48,250	15 350 33,100	*15 700 *33,850	10 000 21,500	11 250 24,100	7000 14,950	8200 17,550	5000 10,650	6450 14,150	3850 8,400	10.34 33.95
Ground Line	kg lb			*22 300 *48,400	14 900 31,950	15 750 33,750	9500 20,450	10 900 23,400	6700 14,300	8050 4850		6900 15,150	4100 9,050	9.91 32.52
-1.5 m -5.0 ft	kg lb	*15 750 *35,700	*15 750 *35,700	*21 050 *45,700	14 900 32,000	15 550 *33,400	9350 20,100	10 800 23,150	6550 14,100			7950 17,500	4800 10,650	9.16 30.02
-3.0 m -10.0 ft	kg lb	*24 100 *52,350	*24 100 *52,350	*18 600 *40,200	15 250 32,750	*14 150 *30,450	9500 20,400	*10 450 *22,150	6700 14,450			*7100 *15,550	6300 14,050	8.01 26.12
-4.5 m -15.0 ft	kg lb			*14 300 *30,450	*14 300 *30,450	*10 550 *22,000	10 000 21,550					*9050 *19,800	8850 *19,800	6.49 21.06

BOOM – 6.55 m (21'6")
STICK – 2.5 m (8'3")

BUCKET – 2.4 m³ (3.14 yd³)
SHOES – 600 mm (23.62") triple grouser

UNDERCARRIAGE – Long – fixed gauge
COUNTERWEIGHT – 8 ton (17,637 lb)

	3.0 m/10.0 ft		4.5 m/15.0 ft		6.0 m/20.0 ft		7.5 m/25.0 ft		9.0 m/30.0 ft				m ft	
														
7.5 m 25.0 ft	kg lb						*9400 8400				*5850 *12,900	5750 *12,900	9.26 30.14	
6.0 m 20.0 ft	kg lb						*9700 *21,100	8300 17,750			*5800 *12,800	4750 10,500	9.99 32.65	
4.5 m 15.0 ft	kg lb			*16 700 *35,800	*16 700 *35,800	*12 600 *27,150	11 900 25,650	*10 450 *22,600	8000 17,100	*9200 5450	*5950 *13,100	4150 9,200	10.38 34.03	
3.0 m 10.0 ft	kg lb			*20 400 *43,800	17 100 36,950	*14 350 *30,950	10 950 23,600	*11 350 *24,550	7550 16,150	*9550 20,500	5300 11,300	*6300 *13,800	3900 8,600	10.50 34.44
1.5 m 5.0 ft	kg lb			*20 000 *48,250	15 650 33,650	*15 700 *33,850	10 150 21,850	*12 100 *26,150	7100 15,250	9350 20,050	5100 10,900	*6850 *15,000	3900 8,600	10.34 33.95
Ground Line	kg lb			*22 300 *48,400	15 150 32,550	*16 200 *35,000	9700 20,850	*12 400 *26,800	6800 14,600	9250 5000		*7650 *16,850	4200 9,250	9.91 32.52
-1.5 m -5.0 ft	kg lb	*15 750 *35,700	*15 750 *35,700	*21 050 *45,700	15 200 32,550	*15 750 *34,050	9550 20,500	*12 050 *25,950	6700 14,400			*8000 *17,550	4900 10,850	9.16 30.02
-3.0 m -10.0 ft	kg lb	*24 100 *52,350	*24 100 *52,350	*18 600 *40,200	15 500 33,300	*14 150 *30,450	9700 20,800	*10 450 *22,150	6850 14,700			*7100 *15,550	6450 14,350	8.01 26.12
-4.5 m -15.0 ft	kg lb			*14 300 *30,450	*14 300 *30,450	*10 550 *22,000	10 150 21,900					*9050 *19,800	9050 *19,800	6.49 21.06

* Limited to hydraulic capacity rather than tipping load. The above loads are in compliance with hydraulic excavator lift capacity rating standard SAE J/ISO 10567. They do not exceed 87% of hydraulic lifting capacity or 75% of tipping capacity. All lifts with heavy lift on.

Standard Equipment

Standard equipment may vary. Consult your Caterpillar dealer for details.

Air conditioner, heater, defroster with automatic climate control
Auto-lube ready
Auxiliary hydraulic valve and auxiliary pump drive location
Ashtray with lighter
Bolt-on FOGS capability
Coat hook
Counterweight 7611 kg (16,780 lb)
Engine
 Cat C13 with ACERT™ Technology
 Speed control, automatic
Floor mat
Fuel-water separator
Hydraulic neutralizer lever for all controls
Light, interior
Lights, working
 Frame mounted
 Boom, both sides
Literature compartment
Mirrors, frame and cab

Monitor, full graphic color display
Positive filtered ventilation
Radio mounting (DIN size)
Seat belt, retractable
Seat, suspension
Skylight, openable, with sunshade
S•O•SSM analysis, engine and hydraulic sampling ports
Start-up level checks (engine oil & coolant, hydraulic oil)
Storage compartment suitable for a lunch box cooler
Swing parking brake, automatic
Track
 600 mm (24 in) triple grouser shoes for variable undercarriage
 750 mm (30 in) triple grouser shoes for standard and long fixed undercarriage
Grease lubricated
Guiding guards, idler and center sections
Windshield wiper and washer

Optional Equipment

Optional equipment may vary. Consult your Caterpillar dealer for details.

Auto-lube system

Auxiliary controls

Hammer (one-way), thumb (two-way), combined (tool control)

Auxiliary hydraulic lines for reach booms and sticks

Auxiliary hydraulic valve and pump attachments

Booms

Long reach 7.4 m (24 ft 3 in) – (on demand only)

Mass excavation 6.55 m (21 ft 6 in)

Reach, Special Application 6.9 m (22 ft 8 in)

Buckets (see pages 12, 22, 23 and 24)

Bucket linkage:

TB family (with lift eye)

VB family

Bucket sidecutters and tips

Cab

Tempered glass windows

Polycarbonate windows

Power supply, 12V – 7A (1)

Rear window emergency exit

Seat, high-back air suspension

Seat, high-back air suspension with heater

Seat, high-back mechanical suspension

Seat, low-back suspension seat without headrest

Headrest

Sunscreen

Windshield wiper, lower with washer

Check valves

Boom lowering

Stick lowering

Counterweight

Counterweight 8110 kg (17,880 lb)

Counterweight 9013 kg (19,870 lb)

Coupler

Coupler control with piping (on demand only)

Electric refueling pump

Engine

Auto-reverse cooling fan

Cold weather starting aid (ether aid, heavy-duty batteries and jump receptacle)

High ambient cooling package 52° C (125° F)

Pre-cleaner

Radiator screen

Guards

Falling Object, for cab

Front window

Heavy-duty, under house

Net front guard

Swivel guard

Vandalism protection

Guiding, full length

Guiding, sprocket end

Hand control pattern changer

Heavy lift mode

Lights, cab mounted

Product Link ready

Sticks

2.5 m (8 ft 2 in) M

2.9 m (9 ft 6 in) R/SA

3.0 m (9 ft 10 in) M

3.35 m (10 ft 10 in) R/SA

3.9 m (12 ft 10 in) LR/R/SA

4.3 m (14 ft 1 in) LR/R/SA (on demand only)

Track

600 mm (24 in) double-grouser shoes

750 mm (30 in) double-grouser shoes

750 mm (30 in) triple-grouser shoes

900 mm (36 in) triple-grouser shoes

Undercarriage

Standard fixed

Long fixed

Variable

Water level indicator for water separator

345C/345C L Hydraulic Excavator

For more complete information on Cat products, dealer services,
and industry solutions, visit us on the web at www.cat.com

© 2007 Caterpillar
All Rights Reserved
Printed in U.S.A.

Materials and specifications are subject to change without notice.
Featured machines in photos may include additional equipment.
See your Caterpillar dealer for available options.

CAT, CATERPILLAR, their respective logos, "Caterpillar Yellow" and the
POWER EDGE trade dress, as well as corporate and product identity used herein,
are trademarks of Caterpillar and may not be used without permission.

AEHQ5622-02 (1-07)

APD

Replaces AEHQ5622-01

CATERPILLAR[®]